

Phonak DECT

Cordless phone / Schnurlostelefon /
Téléphone sans fil / Teléfono inalámbrico

Quick setup guide / Schnellstartanleitung /
Guide d'installation rapide / Guía rápida de instalación



PHONAK
life is on

This quick setup guide is valid for
Diese Schnellstartanleitung gilt für
Ce guide d'installation rapide s'applique aux modèles
suivants
Esta guía rápida de instalación es válida para

Phonak DECT CP1

Phonak DECT II

Components
Komponenten
Composants
Componentes

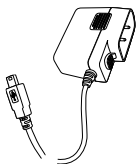

EU



US/CAN



D



CH

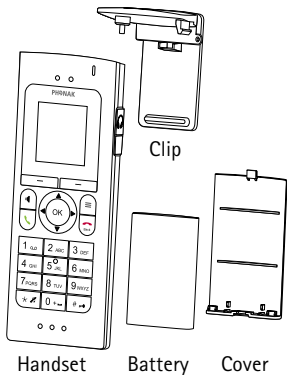

Handset

Battery

Cover

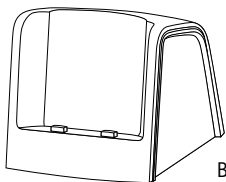

Base



English

- 1 Volume control
- 2 Volume boost
Press 2 sec. =
Hearing aid test
- 3 Hands-free on/off
- 4 Talk/call repeat
- 5 Press 2 sec. =
Call voicebox
- 6 Press 2 sec. =
Ringer on/off
- 7 Press 2 sec. =
Keypad lock on/off
- 8 Navigation keys
- 9 End call / Back
Press 2 sec. =
Phone on/off
- 10 Function key
- 11 Context menu
- 12 Indicator light

Deutsch

- 1 Lautstärke
- 2 Zusatzverstärkung
2 Sek. drücken =
Hörgerät testen
- 3 Freisprechen ein/aus
- 4 Anruf annehmen/
Wahlwiederholung
- 5 2 Sek. drücken =
Sprachbox
- 6 2 Sek. drücken =
Klingelton aus/ein
- 7 2 Sek. drücken =
Tastensperre ein/aus
- 8 Steuertasten
- 9 Auflegen / Zurück
2 Sek. drücken =
Telefon aus/ein
- 10 Funktionstaste
- 11 Kontextmenü
- 12 Hinweis-Licht



Keys and main functions
Tasten und Hauptfunktionen
Touches et fonctions principales
Teclas y funciones principales

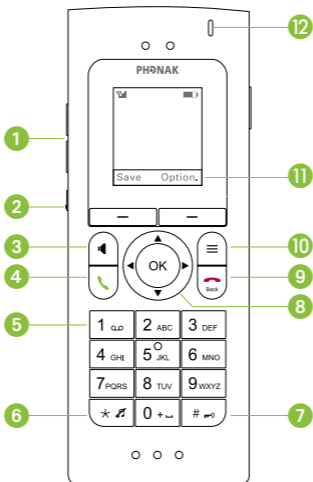



Français

- 1 Contrôle du volume
- 2 Augmentation du volume
Appuyer 2 s =
Test de l'aide auditive
- 3 Activer/Désactiver l'option mains-libres
- 4 décrocher/Rappeler
- 5 **Appuyer 2 s =**
Appeler la boîte vocale
- 6 **Appuyer 2 s =**
Activer/Désactiver la sonnerie
- 7 **Appuyer 2 s =**
Activer/Désactiver le verrouillage clavier
- 8 Touches de navigation
- 9 Raccrocher/Retour
Appuyer 2 s =
Marche/Arrêt du téléphone
- 10 Touche fonction
- 11 Menu contextuel
- 12 Témoin

Español

- 1 Control de volumen
- 2 Subir volumen
Pulse 2 segundos =
Prueba de audífono
- 3 Activar/Desactivar manos libres
- 4 Hablar/Repetir llamada
- 5 **Pulse 2 segundos =**
Llamar al buzón de voz
- 6 **Pulse 2 segundos =**
Activar/Desactivar timbre
- 7 **Pulse 2 segundos =**
Activar/Desactivar bloqueo del teclado
- 8 Teclas de navegación
- 9 Finalizar llamada/Atrás
Pulse 2 segundos =
Activar/Desactivar teléfono
- 10 Tecla de función
- 11 Menú contextual
- 12 Luz indicadora

Connect to power and phone line
Anschluss an Strom- und Telefonleitung
Branchement à l'alimentation et à la ligne téléphonique
Conecte a la toma de corriente y a la línea telefónica

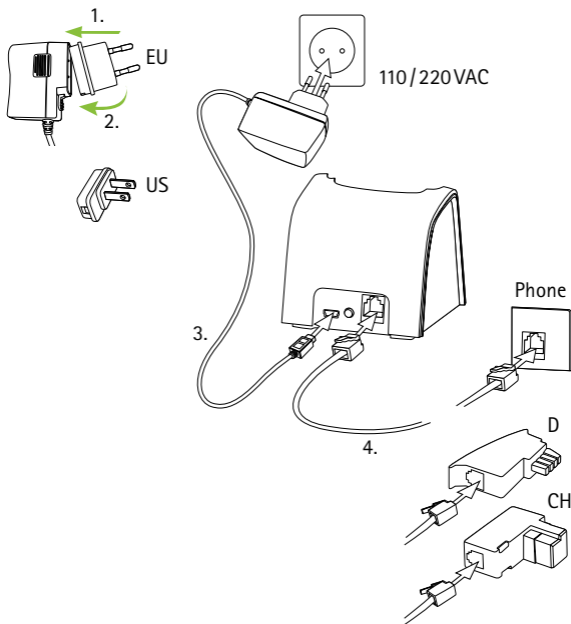

Insert battery into handset (match contacts!)

Batterie in Mobilteil einsetzen (Kontakte beachten!)

Insérer la batterie dans le combiné (aligner les contacts !)

Introduzca la pila en el teléfono (los contactos deben coincidir)

1.

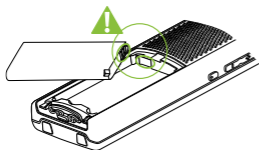

2.

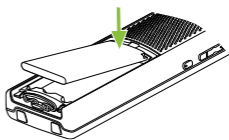

3.

"click"

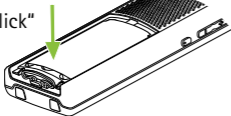

4.

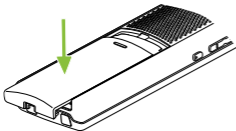

5.

"click"



Follow initial setup
Der Erstinstallation folgen
Suivre l'installation initiale
Siga el menú de configuración inicial



Select language
→ Select country and time

Sprache wählen
→ Land und Uhrzeit setzen.

Sélectionner la langue
→ Sélectionner le pays et l'heure

Selecione el idioma
→ Seleccione país y hora

Initial charging: Minimum 8 hours

Zu Beginn mindestens 8 Stunden laden

Chargement initial : 8 heures minimum

Carga inicial: mínimo 8 horas

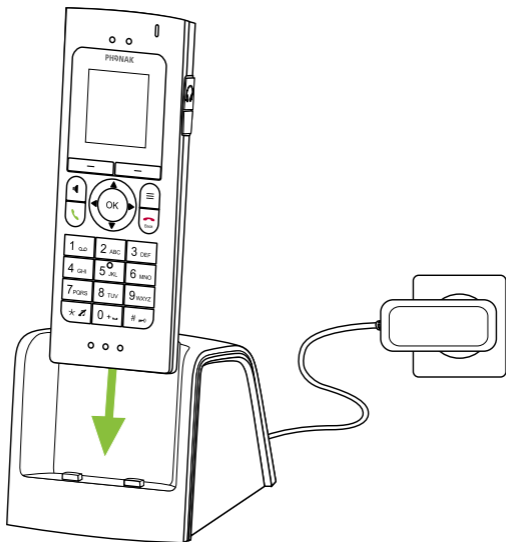

Check connection to hearing aids
Verbindung zu den Hörgeräten prüfen
Aide auditive : vérifier connexion
Audifono: Comprobar conexión

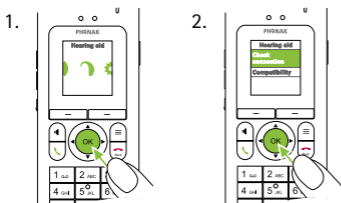

3.

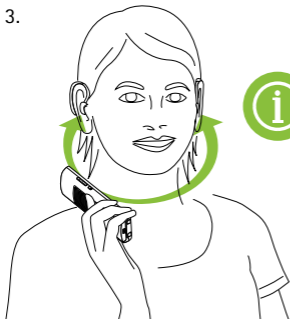

max. 25 cm / 10"



Signal strength base / Signalstärke Basis /
Intensité du signal à la base / Base de intensidad
de la señal

100% 75% 50% 25% 10%

Battery / Batterie / Batterie / Pila

100% 75% 50% 25% 0%

Charging / Laden / Recharge / Cargando

Others / Andere / Autres / Otros

Volume boost on / Zusatzverstärkung ein /
Augmentation du volume activée /
Subir volumen activado

Keypad locked / Tastatur gesperrt / Clavier verrouillé /
Teclado bloqueado

Ringer off / Klingelton aus / Sonnerie désactivée /
Timbre desactivado

Alarm-clock on / Wecker ein / Réveil activé /
Alarma activada

Phone microphone off / Telefon Mikrofon aus /
Microphone du téléphone désactivé /
Micrófono del teléfono desactivado

The user guide will give you detailed information about the installation.

Die Gebrauchsanweisung informiert detailliert über die Installation.

Le mode d'emploi vous donne des informations détaillées sur l'installation.

Las instrucciones de uso le darán una información más detallada sobre su instalación.



Phonak AG
Laubisrütistrasse 28
CH-8712 Stäfa
Switzerland

www.phonak.com

